

APPLICATION OF ADAPTIVE NEURO-FUZZY INFERENCE SYSTEM TECHNIQUE IN DESIGN OF RECTANGULAR MICROSTRIP PATCH ANTENNAS

K. V. Rop¹, D. B. O. Konditi², H. A. Ouma³ and S. Musyoki¹

¹*Jomo Kenyatta University of Agriculture and Technology, Nairobi, Kenya*

²*Multimedia University, Nairobi, Kenya.*

³*University of Nairobi, Kenya*

E-mail: vikrop@gmail.com

Abstract

The recent explosion in information technology and wireless communications has created many opportunities for enhancing the performance of existing signal transmission and processing systems and has provided a strong motivation for developing novel devices and systems. An indispensable element of any wireless communication system is the antenna. microstrip patch antenna (MPA) is well suited for wireless communication due to its light weight, low volume and low profile planar configuration which can be easily conformed to the host surface. In this paper, an adaptive neuro-fuzzy inference systems (ANFIS) technique is used in design of MPA. This artificial Intelligence (AI) technique is used in determining the parameters used in the design of a rectangular microstrip patch antenna. The ANFIS has the advantages of expert knowledge of fuzzy inference system (FIS) and the learning capability of artificial neural network (ANN). By determining the patch dimensions and the feed point of a rectangular microstrip antenna, this paper shows that ANFIS produces good results that are in agreement with Antenna Magus simulation results.

Key words: Artificial intelligence (AI), microstrip patch antennas (MPAs), adaptive neuro-fuzzy inference system (ANFIS)

1.0 Introduction

The demand for a small, reliable, and economical production process, high performance, diverse polarization, low-profile, and lightweight antennas has greatly increased for example, in mobile communications, satellite communication, electronic warfare, biological telemetry, navigation and radar, and surveillance. Microstrip patch antennas are examples of low profile antenna (Rop (1) *et al.*, 2012; Indrasen Singh *et al.*, 2011). These attractive features have increased MPA popularity and application and stimulated greater research effort to understand and improve their performance. MPAs however have limitations in terms of bandwidth and efficiency; all imposed by the very presence of the dielectric substrate (Sandeep Kumar *et al.*, 2012; Guney and Sirikaya, 2004). Often, MPAs are also referred to as patch antennas because of the radiating elements (patches) photo-etched onto the dielectric substrate. The radiating patch may be square, rectangular, circular, triangular, and any other configuration. In this paper, the rectangular microstrip patch antennas are considered.

In the past, analytical and numerical methods have been used to design microstrip patch antennas. The analytical methods, based on some fundamental simplifying physical assumptions regarding the radiation mechanism of antennas, are the most useful for practical designs as well as for providing a good intuitive explanation of the operation of MPAs. However, these methods are not suitable for many structures, in particular, if the thickness of the substrate is significant. The numerical methods are mathematically complex, and still cannot make a practical antenna design feasible within a reasonable period of time. They also, require strong background knowledge, and have time-consuming numerical calculations which need very expensive software packages (Turker, *et al.*, 2006).

Recently, many papers have reported various improved methods used in designing of microstrip patch antennas including the use of various forms of AI (Turker, *et al.*, 2006). In this paper, a method based on the adaptive neuro-fuzzy inference system (ANFIS) is presented. It is shown to be effective in determining the patch dimensions of a coaxial probe fed rectangular microstrip patch antenna. Many papers that have been written on the same field have concentrated on determining only one feature (for example, resonant frequency, patch length/width, or feed points) in the design of MPA. In previous works [Rop (1) *et al.*, 2012], we successfully used ANFIS to determine the parameter of a rectangular MPA and validated the results using Anfis HFSS software. In this paper, ANFIS based methodology is presented for determining the three important features in a design of an MPA; the patch length, patch width, and the feed point. The final results are then validated with the simulation results using Antenna Magus simulation software.

2.0 Overview of Microstrip Patch Antennas

In its most basic form, a microstrip patch antenna consists of a radiating patch on one side of a dielectric substrate and a ground plane on the other side as shown in Figure 1. The bottom surface is a thin dielectric substrate which is completely covered with metallization that serves as a ground plane (Balanis, 1997).

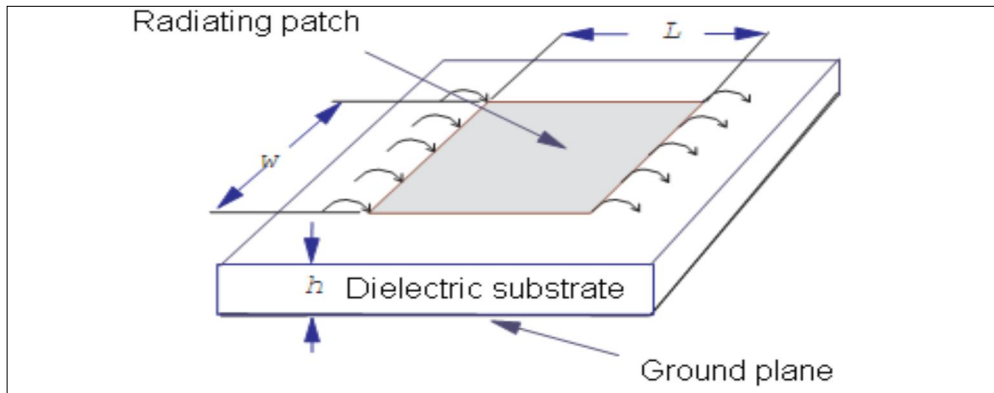

Figure 1: Structure of a Rectangular Microstrip Patch Antenna

The essential properties for consideration in any antenna design are Directivity, Gain, Bandwidth, and Efficiency. Also, depending upon their geometry, MPAs can produce different polarizations. The common and typical types of polarization include the linear (horizontal or vertical) where the path of the electric field vector is back and forth along a line and circular (right hand or the left hand) polarization where the electric field vector remain constant in length but rotates around in a circular path (Saeed and Sabira, 2005).

MPAs can be fed by a variety of methods which are classified into two categories; contacting and non-contacting. The most popular contacting feed techniques used are the microstrip line fed and coaxial probe fed, while the most popular non-contacting feed techniques are aperture coupling fed and proximity coupling fed (Bratislav *et al*, 2005). Coaxial probe fed is the most common feed technique used in the design of microstrip patch antennas due to its low spurious radiation, easy fabrication, and easy input impedance matching, and was thus used in this work.

3.0 Design Methodology

3.1 Design Specifications

The rectangular microstrip antenna is made of a rectangular patch with dimensions width (W) and length (L) over a ground plane with a substrate thickness (h) and dielectric constant (ϵ_r) as shown in Figure 1. There are numerous substrates that can be used for the design of microstrip antennas, and their dielectric constants are usually in the range of $2.2 < \epsilon_r < 12$. The steps followed in the design of rectangular MPAs as discussed in (Rop (2) and Konditi, 2012; Indrasen Singh *et al*, 2011; Turker, *et al*, 2006; Balanis, 1997; Dafalla, 2004; Thakare and Singhal, 2011) are as follows;

The Patch Width (W) for efficient radiation is given as;

$$W = \frac{v_o}{2 f_r} \sqrt{\frac{2}{\epsilon_r + 1}} \dots\dots\dots(1)$$

where, W is the Patch width, v_o is the speed of light, f_r is the resonant frequency, and ε_r is the dielectric constant of the substrate

The Effective Dielectric Constant (ε_{reff}) - Due to the fringing and the wave propagation in the field line, an effective dielectric constant (ε_{reff}) must be obtained from Eq. 2.

$$\epsilon_{reff} = \frac{\epsilon_r + 1}{2} + \frac{\epsilon_r - 1}{2} \left[1 + 12 \frac{h}{W} \right]^{-\frac{1}{2}} \dots\dots\dots (2)$$

where, ε_{reff} is the effective dielectric constant, h is the height of the dielectric substrate

The Effective Length (L_{eff}) for a given resonance frequency f_r is given as;

$$L_{eff} = \frac{c}{2 f_r \sqrt{\epsilon_{reff}}} \dots\dots\dots(3)$$

The Length Extension (ΔL) is given as;

$$\Delta L = 0.412 h \frac{(\epsilon_{reff} + 0.3) \left(\frac{W}{h} + 0.264 \right)}{(\epsilon_{reff} - 0.258) \left(\frac{W}{h} + 0.8 \right)} \dots\dots\dots(4)$$

The Patch Length (L). The actual patch length now becomes;

$$L = L_{eff} - 2 \Delta L \dots\dots\dots(5)$$

The Bandwidth (BW)

$$BW \% = 3.77 \left(\frac{\epsilon_r - 1}{\epsilon_r^2} \right) \left(\frac{W}{L} \right) \left(\frac{h}{\lambda_o} \right) * 100 \% \dots\dots\dots(6)$$

Where, λ_o is the wavelength in free space.

The Feed Co-ordinates:- Using coaxial probe-fed technique, the feed points are calculated as;

$$Y_f = W/2 \dots\dots\dots (7)$$

$$x_f = \frac{L}{2 \sqrt{\epsilon_{reff}}} \dots\dots\dots (8)$$

where, Y_f and X_f are the feed co-ordinates along the patch width and length respectively.

The Plane Ground Dimensions:- It has been shown that MPAs produce good results if the size of the ground plane is greater than the patch dimensions by approximately six times the substrate thickness all around the periphery (Mutiaru *et al.*, 2011).

$$L_g = 6h + L \quad \dots\dots\dots (9)$$

$$W_g = 6h + W \quad \dots\dots\dots (10)$$

where, L_g and W_g are the plane ground dimensions along the patch length and width respectively.

3.2 Architecture of Adaptive Neuro-Fuzzy Inference System (ANFIS)

ANFIS network is organized into two parts like fuzzy systems. The first part is the antecedent and the second part is the conclusion, and the two are connected together by rules to form a network. The ANFIS architecture consists of five layers namely; fuzzy layer, product layer, normalized layer, de-fuzzy layer, and summation (total output) layer as shown in Figure 2 below. In the figure, a circle indicates a fixed node, whereas a square indicates an adaptive node (Turker, *et al.*, 2006; Kasabov and K. Nikola, 1996; Jang, 1993).

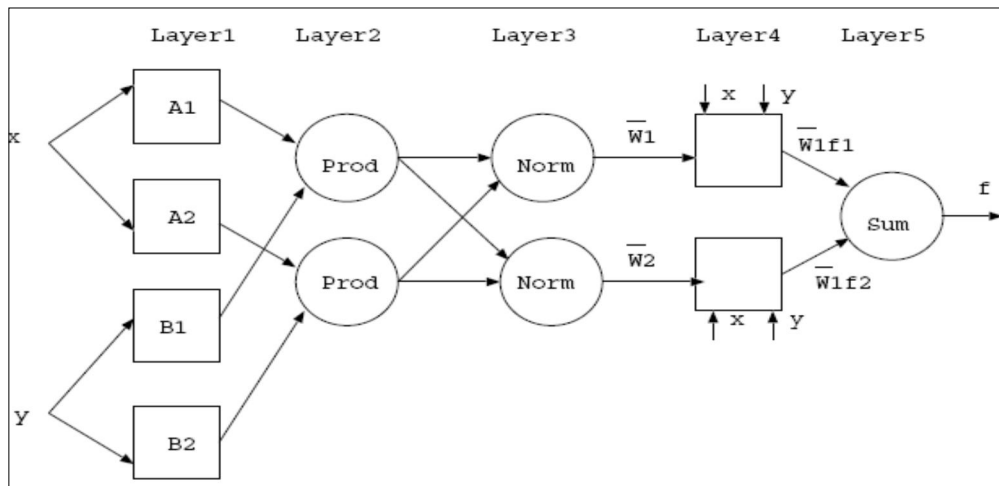

Figure 2: Architecture of an ANFIS

Assume that the fuzzy inference system under consideration has two inputs x and y and one output z . Based on a first-order Sugeno model, a typical rule set with two fuzzy if-then rules can be expressed as;

Rule1: If x is A_1 and y is B_1 , then $f_1 = p_1x + q_1y + r_1$
 (11)

Rule2: If x is A_2 and y is B_2 , then $f_2 = p_2x + q_2y + r_2$
 (12)

where, A_1, B_1, A_2, B_2 are fuzzy sets, p_i, q_i and r_i ($i = 1, 2$) are the coefficients of the first-order polynomial linear functions.

The five layer of Figure 2 are as follows.

Layer 1 is the Fuzzy Layer, in which x and y are the input of nodes A_1, B_1 , and A_2, B_2 respectively. A_1, B_1, A_2 , and B_2 are the linguistic labels used in the fuzzy theory for dividing the membership functions. The membership relationship between the output and input functions of this layer can be expressed as;

$$O_{1,i} = \mu_{A_i}(x), \quad i = 1, 2 \quad (13)$$

$$O_{1,j} = \mu_{B_j}(y), \quad j = 1, 2 \quad (14)$$

where $O_{1,i}$ and $O_{1,j}$ denote the output functions, whereas μ_{A_i} and μ_{B_j} denote the membership functions respectively.

Layer 2 is the Product Layer that consists of two nodes labeled Prod. The output w_1 and w_2 are the weight functions of the next layer. The output of this layer ($O_{2,i}$) is the product of the input signal and is defined as;

$$O_{2,i} = w_i = \mu_{A_i}(x) \mu_{B_j}(y), \quad i, j = 1, 2 \quad (15)$$

Layer 3 is the Normalized Layer. This layer calculates the ratio of the i^{th} rule's firing strength to the sum of the entire rule's firing strengths. The output is denoted as $O_{3,i}$ and is defined in Eq. 16.

$$O_{3,i} = \bar{w}_i = \frac{w_i}{w_1 + w_2}, \quad i = 1, 2 \quad (16)$$

Layer 4 is the De-fuzzy Layer whose nodes are adaptive. p_i, q_i and r_i denote the linear parameters which are also called consequent parameters of the node. The de-fuzzy relationship between the input and output of this layer can be defined as Eq. 17, where $O_{4,i}$ denotes the Layer 4 output.

$$O_{4,i} = \bar{w}_i f_i = \bar{w}_i (p_i x + q_i y + r_i) \quad (17)$$

Layer 5 is the Total Output Layer whose single node is labeled as Σ . The output of this layer denoted as $O_{5,1}$, is the total of input signals. The results can be expressed as;

$$O_{5,1} = \sum_i \bar{w}_i f_i = \frac{\sum_i w_i f_i}{\sum_i w_i} \quad (18)$$

Substituting Eq. 3-16 into Eq. 3-18 yields

$$f = \bar{w}_1 f_1 + \bar{w}_2 f_2 \quad (19)$$

ANFIS uses Sugeno FIS model. The Sugeno fuzzy model provides a systematic approach to the generation of fuzzy rules from a set of input–output data pairs. The ANFIS systems also employs the use of hybrid learning algorithm by combining the least-squares method (LSM) and the back-propagation (BP) algorithm for its learning and training process. During the learning process, the premise parameters in the Layer 1 and the consequent parameters in the Layer 4 are tuned until the desired response of the FIS is achieved (Guney and Sirikaya, 2006). The hybrid learning algorithm is a two-step process. First, while holding the premise parameters fixed, the functional signals are propagated forward to Layer 4, where the consequent parameters are identified by the LSM. Then, the consequent parameters are held fixed while the error signals, the derivative of the error measure with respect to each node output, are propagated from the output end to the input end, and the premise parameters are updated by the standard BP algorithm. This process is repeated until the results are deemed satisfactory (the training error becomes zero) or once it reaches a specified epoch number (Sivanandam *et al*, 2007).

3.3 Application of ANFIS in the design of a Rectangular Microstrip Patch Antenna

As discussed above, ANFIS uses a set of data for training of its network. There are two types of data generators (measurements and simulations) for antenna applications. The selection of a data generator depends on the application and the availability of the data generator. In this paper, the ANFIS model shown in Figure 3 with the inputs substrate height (h), resonant frequency (f_r), and , dielectric constant (ϵ_r) and the outputs patch width (Wt), patch length (Lt), and the feed point along the width and length (Y_f , X_f) respectively, illustrates how parameters used in the design of rectangular microstrip patch antenna are optimized.

The ANFIS can simulate and analyze the mapping relation between the input and output data through a learning algorithm so as to determine the parameters used in design of microstrip antennas. The training and test data sets used in this work have been obtained from both simulations and previous experimental works which are documented in various refereed journals (such as Guney and Sirikaya, 2006; Turker, *et al*, 2006; Jang, 1993).

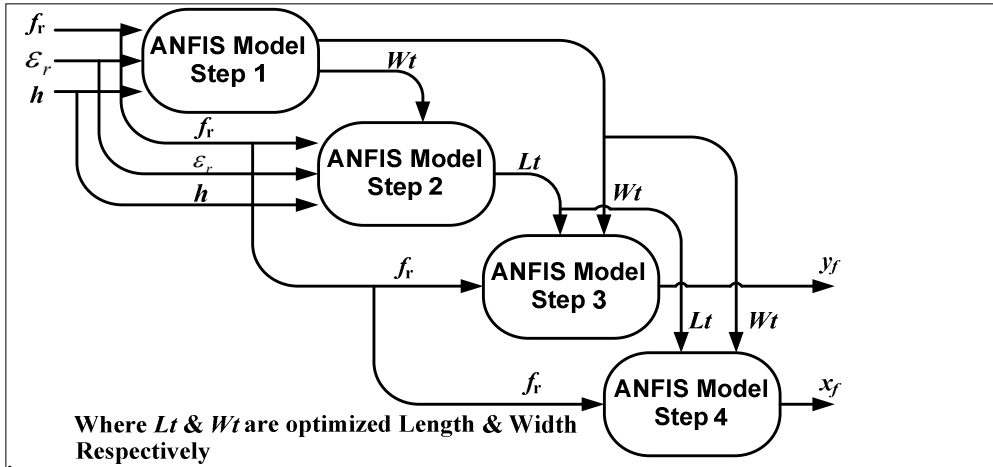

Figure 3: ANFIS Model for Design of Rectangular MPA

As illustrated in Figure 3, the ANFIS model contains four stages. In the first stage, resonant frequency, dielectric constant, and substrate height are used in optimizing the patch width (W) of the antenna. 90 and 18 data sets were used for training and testing respectively. The membership functions (MFs) for the input variables f_r , ϵ_r , and h , are 4, 3, and 3 respectively. The number of rules is then 36 ($4 \times 3 \times 3$) and the number of epochs is specified as 700. In the second stage, the antenna patch length (L) is optimized. The three input variables used in first stage are maintained with the addition of the optimized patch width (W_t) as an input variable, therefore, variables f_r , ϵ_r , h , and W_t were used as inputs with L as the output variable to be optimized. 90 training data sets and 16 testing data sets were used in this stage. The MFs for the input variables f_r , ϵ_r , h , and W_t are 4, 2, 2, and 4 respectively thus, the number of rules is 64 ($4 \times 2 \times 2 \times 4$) with the number of iterations specified as 700. The third and fourth stage in the ANFIS model is used for optimizing the feed point (Y_f) along the patch width and (X_f) along the patch length respectively. In this stage, the number of epochs is specified as 600 with 90 testing data sets and 15 testing data sets used. The variables f_r , W_t , and L_t are used as inputs with the MFs as 3, 4, and 4 respectively. This gives the number of rules as 48 ($3 \times 4 \times 4$).

4.0 Results and Discussions

By using ANFIS implemented in MATLAB® platform, training and testing of data sets was carried out. Also using Antenna Magus software, simulation was carried out to generate the values of various rectangular MPA parameters namely patch width, patch length, and feed points. Finally ANFIS optimized data were validated with the Antenna Magus simulated data and the results tabulated and plotted.

As illustrated in Figure 3, ANFIS model used in this work has four stages. In each stage, training is carried out as per the specified number of epoch. Using the Eq. 1

to 10, training data sets were generated. Testing data sets were also collected (from Guney and Sirikaya, 2006; Turker, *et al*, 2006; Sivanandam *et al*, 2007) and the overall ANFIS design model formulated. With the emphasis on FR4 Glass-Epoxy substrate (with dielectric constant of 4.35 and substrate height of 1.6mm) operating at 2GHz, various substrates were used in determining the best possible parametric values for rectangular microstrip patch antenna. As illustrated in (Guney and Sirikaya, 2006), the substrate thickness is inversely proportional to dielectric constant with reference to bandwidth. Figure 4 plots various MPA parameters with relation to resonant frequency.

Table 1 shows a summary of the specified design parameters and the output root mean square error (RMSE). The error goal was set at default 0 with the initial step size set at 0.04.

Table 1: Summary of ANFIS Model Variables

| ANFIS Stage | Output Variable | Input Variables | Step Size Learning Rate | | RMSE Error | Prediction |
|-------------|-----------------|---------------------------|-------------------------|---------------|------------|------------|
| | | | Decrease Rate | Increase Rate | | |
| 1 | W_t | f_r, ϵ_r, h | 0.9 | 1.1 | 0.5180 | |
| 2 | L_t | f_r, ϵ_r, h, W_t | 0.9 | 1.1 | 0.0052 | |
| 3 | Y_{ft} | f_r, W_t, L_t | 0.9 | 1.1 | 0.0194 | |
| 4 | X_{ft} | f_r, W_t, L_t | 0.9 | 1.1 | 0.1770 | |

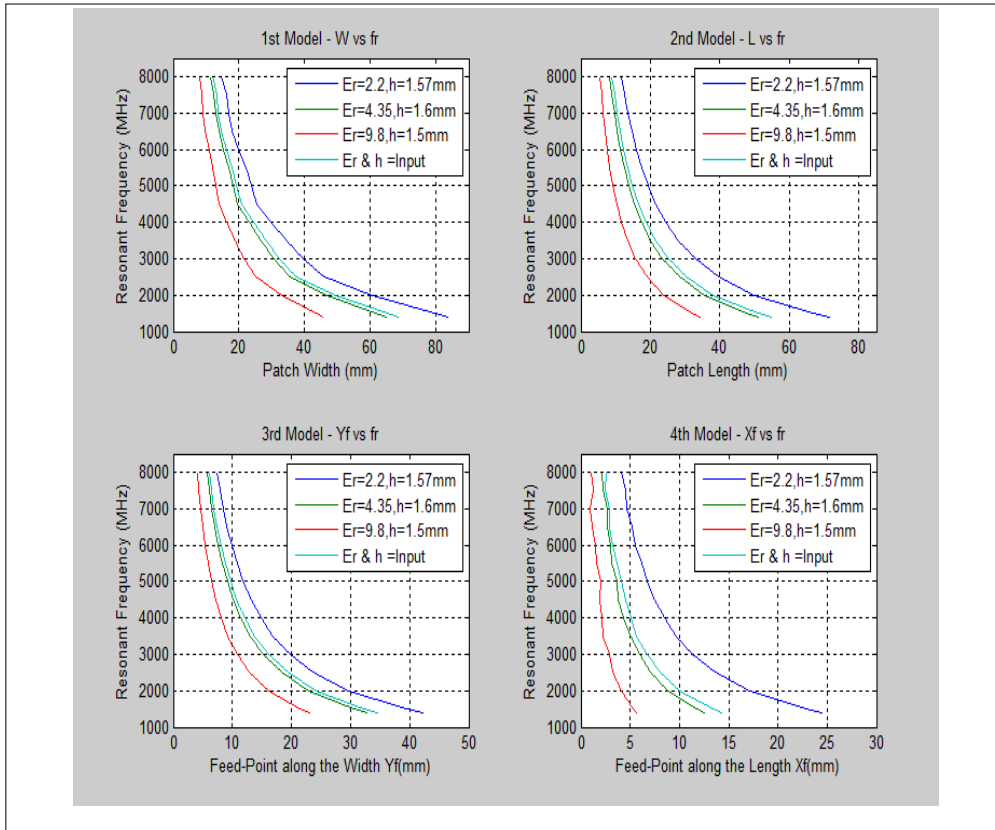

Figure 4: ANFIS Output Values for Rectangular MPA with various Dielectric Constants and Substrate Heights

As depicted in Figure 4 the patch dimensions vary as per the type of substrate material used in relation to resonant frequency. The substrates used were Duroid 5880 with dielectric constant of 2.2 and substrate thickness of 1.57mm, FR4 Glass-Epoxy with substrate thickness of 1.6mm and dielectric constant of 4.35, aluminum with dielectric constant of 9.8 and substrate thickness of 1.5mm, and quartz with dielectric constant of 3.8 and substrate thickness of 1.5mm. Also, it can be seen that the higher the resonant frequency the smaller the patch antenna therefore, it not be practical to use this type of an antenna for operational frequencies above 6 GHz because the fabrication process for relatively small sized antennas is quite difficult and it power handling capability is greatly reduced.

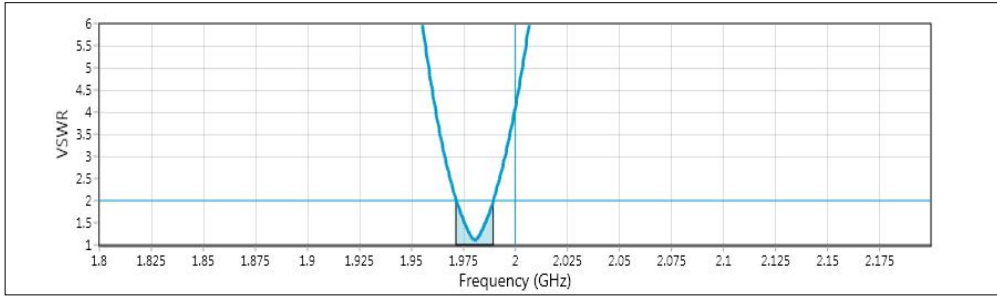

Figure 5: VSWR of Rectangular Microstrip Patch Antenna at 2GHz

For proper operation of MPA, the value of voltage standing wave ratio (VSWR) should always be less than 2. As shown in Figure 5, this MPA functions are well within the frequency range of approximately 1.971GHz and 1.989GHz where the VSWR is less than 2 with a bandwidth of about 12MHz. VSWR is minimum (1.107) at a frequency of 1.98GHz. from Figure 5, VSWR at exactly 2GHz is about 4, and therefore, a significant transmitted power loss. This loss can be greatly attributed to the impedance mismatch

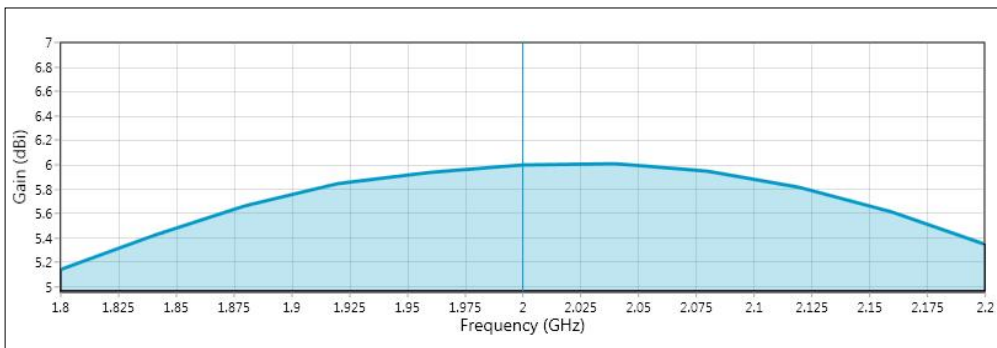

Figure 6: Gain of Rectangular Microstrip Patch Antenna at 2GHz

The gain of a basic MPA is between 5-8 dB. As shown in Figure 6 and Figure 7, the gain from Antenna Magus software simulation is seen to be maximum (about 6dB) at a frequency of about 2.04GHz.

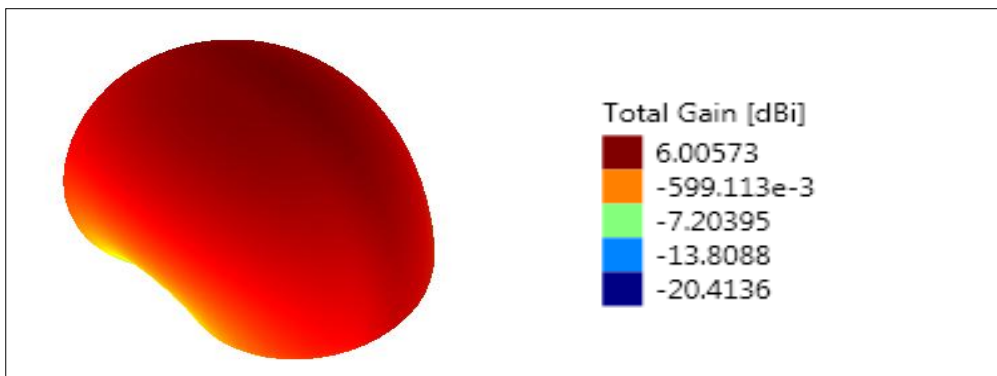

Figure 7: Gain of Rectangular Microstrip Patch Antenna at 2GHz

Table 2 shows the comparison between Antenna Magus simulated data and ANFIS model simulated data operating at 2GHz for FR4 substrate material.

| Antenna Parameters | ANFIS Model | Antenna Magus | Error Difference |
|---------------------|-------------|---------------|------------------|
| W (mm) | 46.818 | 45.86 | 0.993 |
| L (mm) | 35.631 | 35.64 | 0.388 |
| Y _f (mm) | 22.927 | 22.93 | 0.015 |
| X _f (mm) | 8.819 | 6.0 | -3.929 |

5.0 Conclusion

The representative parameters computed by using ANFIS presented in this paper for rectangular microstrip patch antenna are listed in Table 2 including the simulated data form Antenna Magus software. From the results, it is clear that ANFIS produces good results which are in good agreement with the Antenna Magus simulated data. The agreement shown in these results supports the validity of the ANFIS model proposed in this paper.

A lot of research in this field has been with the use of artificial intelligent techniques in calculating the design parameters of various patch antennas. However, not much of this has been directed to optimizing the feed point. The error margin with the feed point is a subject of further research aiming to reduce the same. This work therefore shows that artificial intelligent technique; ANFIS can be used to effectively design MPAs.

References

- Rop K. V. (1), D.B.O. Konditi, H.A. Ouma, and S. Musyoki (2012) *Parameter Optimization in Design of a Rectangular Microstrip Patch Antenna using Adaptive Neuro-Fuzzy Inference System Technique*, International Journal on Technical and Physical Problems of Engineering (IJTPE), **4**(3), pp. 16-23
- Sandeep K., Subodh K, Nitin K., Rachit Aggarwal (2012). *Design of Microstrip Square-Patch Antenna for Improved Bandwidth and Directive Gain*, International Journal of Engineering Research and Applications (IJERA), **2**(2), MAR-APR 2012, pp.441-444
- Rop K. V., and Konditi D.B.O. (2012). *Performance Analysis of a Rectangular Microstrip Patch Antenna on Different Dielectric Substrates*, International Institute for Science Technology and Education (IISTE) -Innovative Systems Design and Engineering, **3**(8), pp. 7-14.
- Indrasen S. and Tripathi V.S. (2011). *Microstrip Patch Antenna and its Applications: a Survey*, Int. J. Comp. Tech. Appl.,**2**, pp. 1595-1599.
- Guney and Sirikaya (2004). *Adaptive Neuro-Fuzzy Inference System for Computing of the Resonant Frequency of Circular Microstrip Antennas*, Aces Journal, **19**(3), pp. 188-197.
- Turker N., Gunes F., Yildirim F. (2006). *Artificial Neural Design of Microstrip Antennas*, Turk J Elec Engin Tubitak, **14**(3), pp. 445-453.
- Balanis, Constantine A. (1997). *Antenna Theory – Analysis and Design*, John Wiley & Sons Inc., 2nd Edition, pp. 722-751.
- Saeed A. Rashid and Sabira K. (2005). *Design of Microstrip Antenna for WLAN*, Journal of Applied Sciences 5, Asian Network for Scientific Information, pp. 47-51.
- Bratislav Milovanovic, Marija Milijic, Aleksandar Atanaskovic, and Zoran Stankovic (2005). *Modeling of Patch Antennas using Neural Networks*, Telskiks, Serbia and Montenegro, IEEE, pp. 386-388.
- Guney and Sarikaya (2006). *Adaptive Neuro-Fuzzy Inference Systems for Computation of the Bandwidth of Electrically Thin and Thick Rectangular Microstrip Antennas*, Electrical Engineering Journal 88, Springer-Verlag, pp. 201–210.
- Kasabov and K. Nikola (1996). *Foundations of Neural Networks, Fuzzy Systems, and Knowledge Engineering*, The MIT Press Cambridge, Massachusetts London, England, pp. 1-19, 167-329.

Sivanandam S. N., Sumathi S., and Deepa S. N., (2007). *Introduction to Fuzzy Logic using MATLAB*, Springer-Verlag Berlin Heidelberg, pp. 10-127.

Dafalla, W. T. Y. Kuan, A. M. Abdel Rahman, S.C. Shudakar (2004). *Design of a Rectangular Microstrip Patch Antenna at 1GHz*, RF and Microwave Conference, Subang, Selangor, Malaysia, pp. 145-149.

Thakare and Singhal (2011). *Analysis of Feed Point Coordinates of a Coaxial Feed Rectangular Microstrip Antenna using Mlpffbp Artificial Neural Network*, ICIT 5th International Conference on Information Technology, pp. 1-6.

Mutiara A.B., Refianti R. and Rachmansyah (2011). *Design of Microstrip Antenna for Wireless Communication at 2.4 GHz*, Journal of Theoretical and Applied Information Technology, **33**, No. 2, pp. 184-192.