

MODELING, SIMULATION AND PERFORMANCE EVALUATION OF PARABOLIC TROUGH SOLAR COLLECTOR POWER GENERATION SYSTEM

Mekuannint Mesfin and Ababayehu Assefa
Department of Mechanical Engineering
Addis Ababa University

ABSTRACT

Model of a parabolic trough power plant, taking into consideration the different losses associated with collection of the solar irradiance and thermal losses is presented. MATLAB software is employed to model the power plant at reference state points. The code is then used to find the different reference values which are used as inputs for the TRNSYS programme implemented in the modeling and simulation of the power plant. TRNSYS software is used to simulate the performance of the model at off design weather conditions as well.

Keywords: *Parabolic Trough Collector (PTC); Heat Transfer Fluid (HTF); TRNSYS power plant model; STEC library; Solar Advisor Model (SAM); TRNSYS solar field model; Solar Electric Generation System (SEGS).*

INTRODUCTION

Parabolic troughs are currently most used means of power generation option of solar sources. Solar electric generation systems (SEGS) employ solar collectors to track the sun and use its energy to produce steam. These plants replace the boiler part of a conventional Rankine cycle power plant with solar fields that are used to increase the temperature of heat transfer fluids. The solar field area must however be wide enough to satisfy the power demand. Heat exchangers are used to transfer heat energy from the heat transfer fluid (HTF) to water coming from feedwater heaters.

In this paper a proposed SEGS power plant with a capacity of 10 MWe is discussed, with Addis Ababa selected as the site of operation. For the mentioned capacity of the plant, MATLAB software is used to model the power plant at reference weather conditions. The outputs of the code are used as reference values in TRNSYS modeling and simulation of the plant at off optimum design weather conditions. In the TRNSYS simulation, a library of Solar Thermal Electric Component (STEC) models are used for both solar and conventional power cycle elements, in addition to the built-in TRNSYS components.

SOLAR-FIELD POWER PLANT MODEL

Solar Thermal Electric Components (STEC) developed for a parabolic trough is applied to model the solar field. The solar field model bases itself on the model of Lippke [1] that uses and integrates efficiency equations to account for the different fluid temperatures at the field inlet and outlet of the collector field. It calculates the demanded mass flow rate of the HTF to achieve a pre-defined outlet temperature [2].

MODELING OF THE POWER PLANT

In the modeling part, each component of the power plant is analyzed by properly identifying the inputs and outputs as well as defining and evaluating its efficiency. The power plant to be investigated is assumed to operate using the Rankine power cycle. It has two high pressure and three low pressure turbines, arranged for optimized power generation. Accordingly there are two high and one low pressure closed feedwater heaters. Between the high pressure and low pressure feedwater heaters a deaerator exists. Steam leaving the LP Turbine 3 and cascaded wet-vapor from the feed water heaters is condensed in the condenser. The condensate is pumped to the deaerator pressure, first passing through the LP feed water heater. The feed pump discharges the circulating water to the pressure of the HP Turbine 1, first passing through the train of heat exchangers. The heat exchanger train consists of a feedwater preheater, a steam generator and a superheater, in series and a reheater, in parallel with the other three heat exchangers. The power cycle begins by collecting the HTF returning from the solar field in an expansion vessel. The expansion vessel serves to compensate for variation in the volume of the heat transfer fluid throughout the day, since the specific volume of the HTF is dependent on temperature. The heat transfer fluid is pumped from the expansion vessel and delivered to the heat exchanger train as the energy source for the power cycle. The complete schematic diagram of the power plant is shown in Fig. 1.

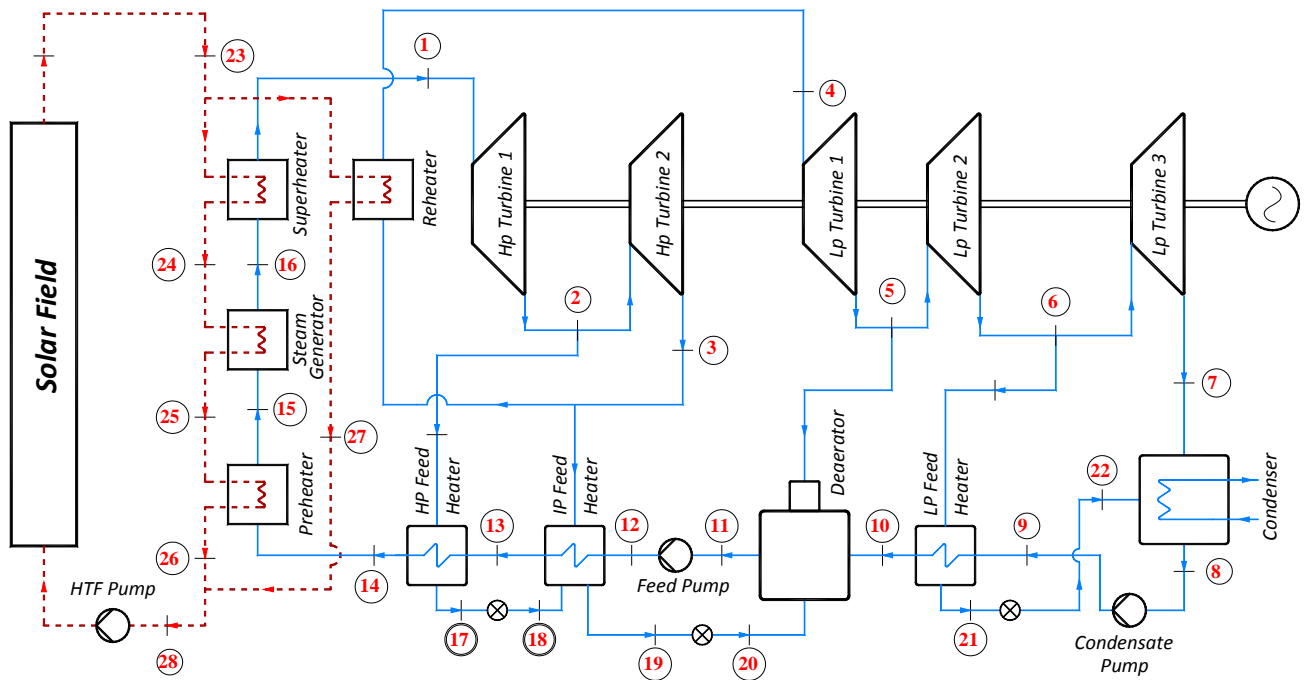

Figure 1 Steam power plant

The optimum design plant efficiency is determined using reference weather conditions of Addis Ababa. Reference ambient temperature and wind speed weather conditions can be found by taking annual average data. Reference direct normal radiation value is set to the actual direct normal radiation value that has a cumulative annual frequency value of about 95 % [3].

The size of solar field area which is required to produce the given power at the optimum design weather conditions could be found by making heat balance between the HTF from the solar field and steam from the Rankine system.

MATLAB code is written to determine the effective solar field area, after determining the different state points and steam and HTF mass flow rates. The flow chart of the code is shown in Fig. 2 and the T-S diagram for the simulated power plant is indicated in Fig. 3.

Properties pressure, temperature, specific enthalpy and specific entropy at all state point are indicated in Table 1. These values are results of the MATLAB model.

SIMULATION OF THE POWER PLANT USING TRNSYS

The purpose of the TRNSYS modeling and simulation is to study the operation of the power plant at weather conditions different from the

reference values. In these weather conditions, the power plant operates by producing less power than the rated capacity. TRNSYS software is selected for the simulation work due to its simplicity and flexibility.

The TRNSYS modeling includes the TRNSYS field model and power model. The solar field model shown in Fig. 4 includes weather data processors, Type 16g and Type 9a. HTF mixer which is use to mix the HTF from the reheater and the preheater is modeled by Type 11. Type 4 is also used to model the expansion vessel. All the above components are part of the Standard TRNSYS library [4].

Parabolic trough collector model (Type 396) is part of the STEC library release 3.0, 2006. The HTF splitter (Type 351), which is used to split the HTF mass flow rate to the super heater, the steam generator, the preheater train and reheater train is used from the same library.

TRNSYS power model is used to estimate the input and output temperatures of the steam from the preheater, steam generator, superheater, turbine stages, condenser, feed water heaters, and closed feed water heaters. The model also determines their variations with the operating conditions. Similarly the mass flow rate of steam, the heat transferred between component stages and the net power output from the plant are determined applying TRNSYS software.

Modeling, Simulation and Performance Evaluation

In the power modeling of the plant using TRNSYS most of the components are part of STEC model

library release 3.0, 2006. Fig. 5 shows the TRNSYS power plant model.

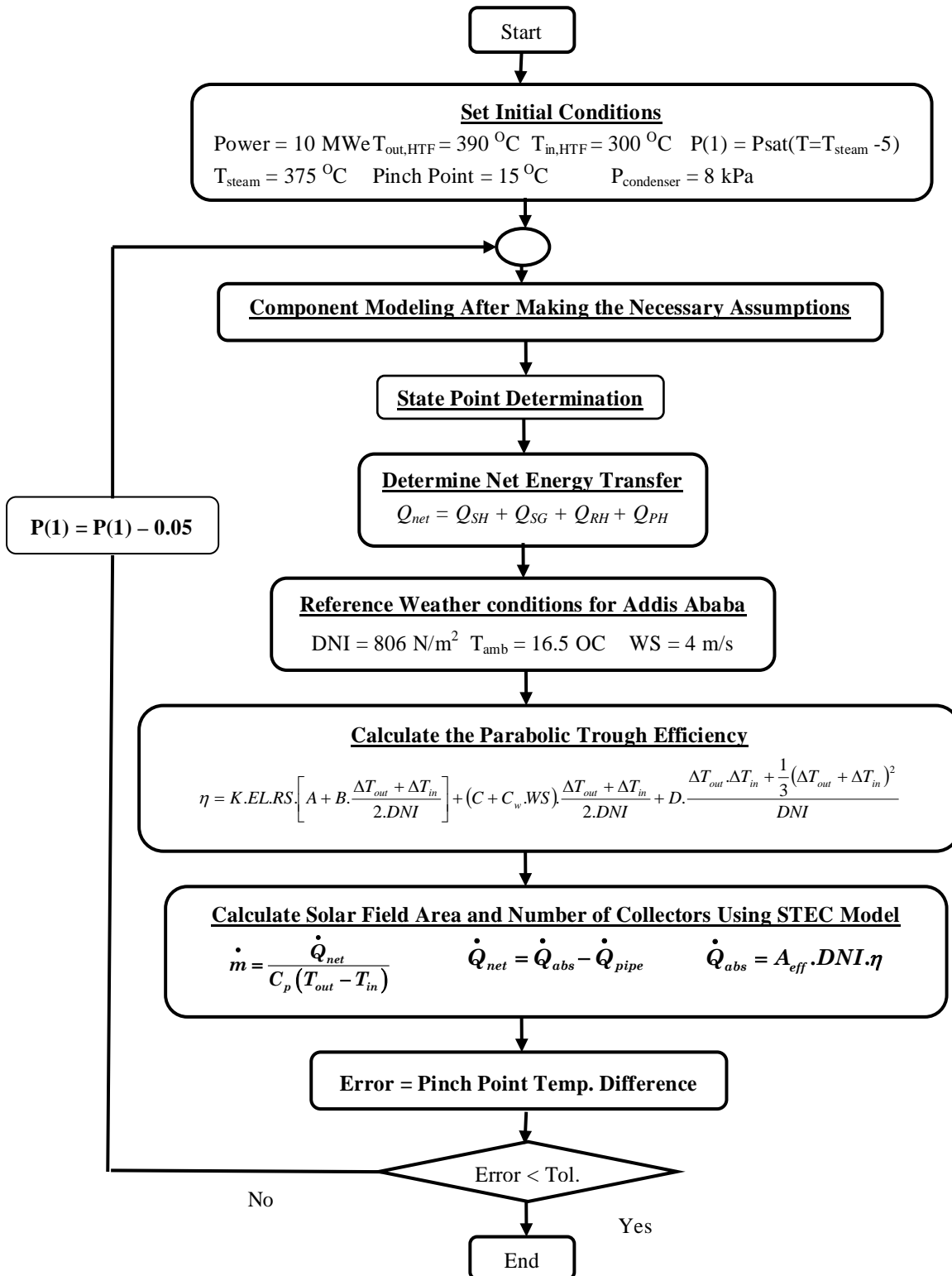

Figure 2 Flow chart for the developed MATLAB code

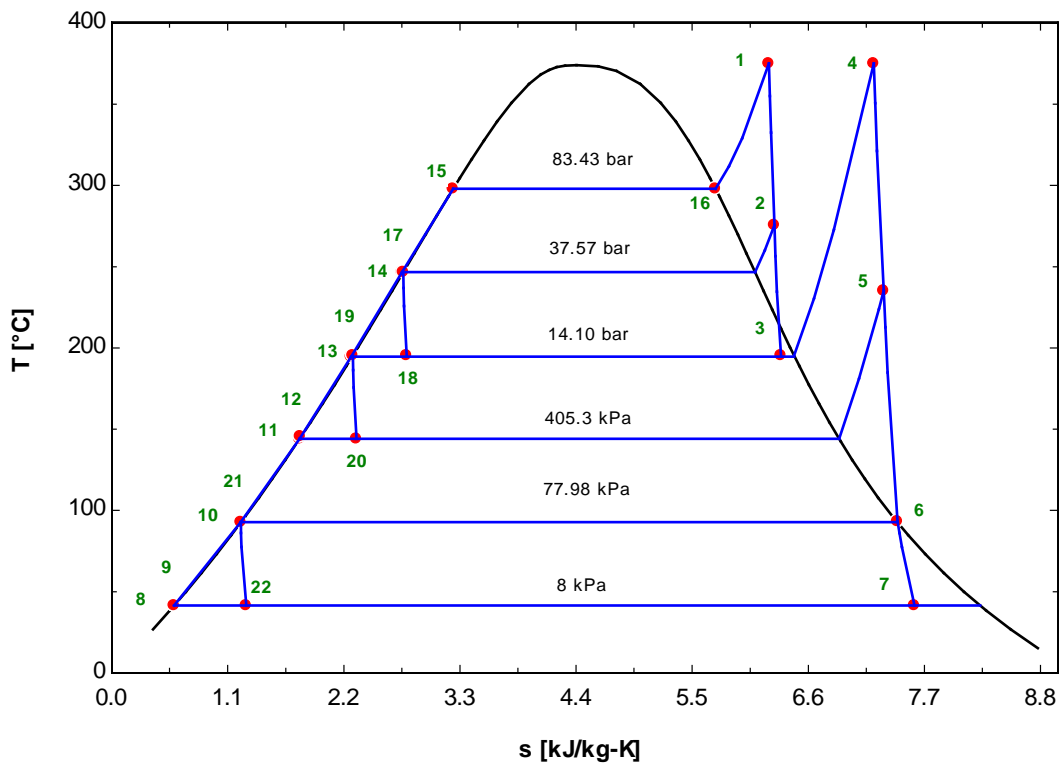

Figure 3 T-s diagram of the power plant

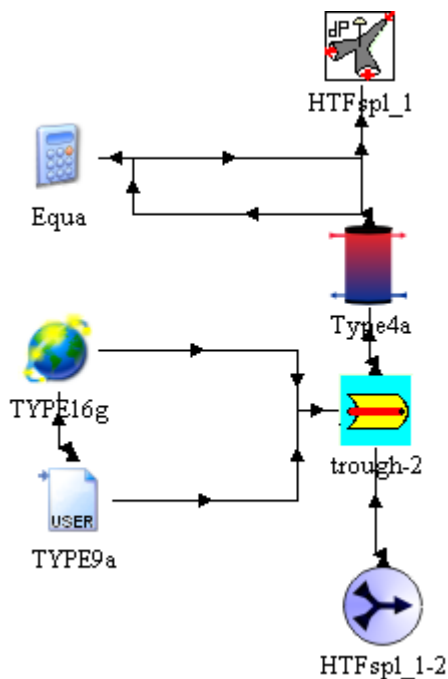

Figure 4 TRNSYS solar field model

In the power modeling of the plant using TRNSYS most of the components are part of STEC model library release 3.0, 2006. Fig. 5 shows the TRNSYS power plant model.

RESULTS OF THE TRNSYS SIMULATION

The reference values for the TRNSYS simulation are found from the full load operation of the power plant which is modeled using MATLAB. The reference values include, area of the solar field, over all heat transfer coefficients of the heat exchangers, design mass flow rate of water/ steam, design inlet and outlet pressures of each turbine stage and, outlet pressures of each turbine stage and mass flow rates of the steam/water and HTF in the heat exchangers.

The simulation is done for year 2001 EC. The weather conditions for Addis Ababa are found from SWERA [5] in a text and TMY formats. The result of the simulation for two days of operation, one clear day (March 16) and one cloudy day (May 15) are given below.

For the clear day simulation, all the mass flow rates and inlet and exit temperatures as well as the power generated are established to be equal to the design value. The cloudy day simulation, however, shows that all the results are highly dependent on DNI values and reinforces the necessity of thermal storage for improved output from this kind of power plants.

Table 1: State points of the power plant (MATLAB output)

State Point	P(i) (kPa)	T(i) (°C)	h(i) (kJ/kg)	s(i) (kJ/kg K)
1	375.00	83.43	3058.55	6.2265
2	275.48	37.57	2899.30	6.2782
3	195.38	14.10	2731.23	6.3415
4	375.00	14.10	3203.89	7.2193
5	235.24	4.05	2933.99	7.3152
6	93.24	0.78	2664.96	7.4449
7	41.51	0.08	2380.27	7.6046
8	41.51	0.08	173.85	0.5925
9	41.57	4.05	174.39	0.5931
10	92.74	4.05	388.75	1.2240
11	144.09	4.05	606.77	1.7815
12	145.60	83.43	618.25	1.7885
13	194.70	83.43	831.62	2.2702
14	246.61	83.43	1069.54	2.7518
15	297.96	83.43	1333.38	3.2354
16	297.96	83.43	2753.40	5.7219
17	246.67	37.57	1069.54	2.7629
18	195.38	14.10	1069.54	2.7948
19	195.38	14.10	831.62	2.2870
20	144.09	4.05	831.62	2.3204
21	92.80	0.78	388.75	1.2250
22	41.51	0.08	388.75	1.2755

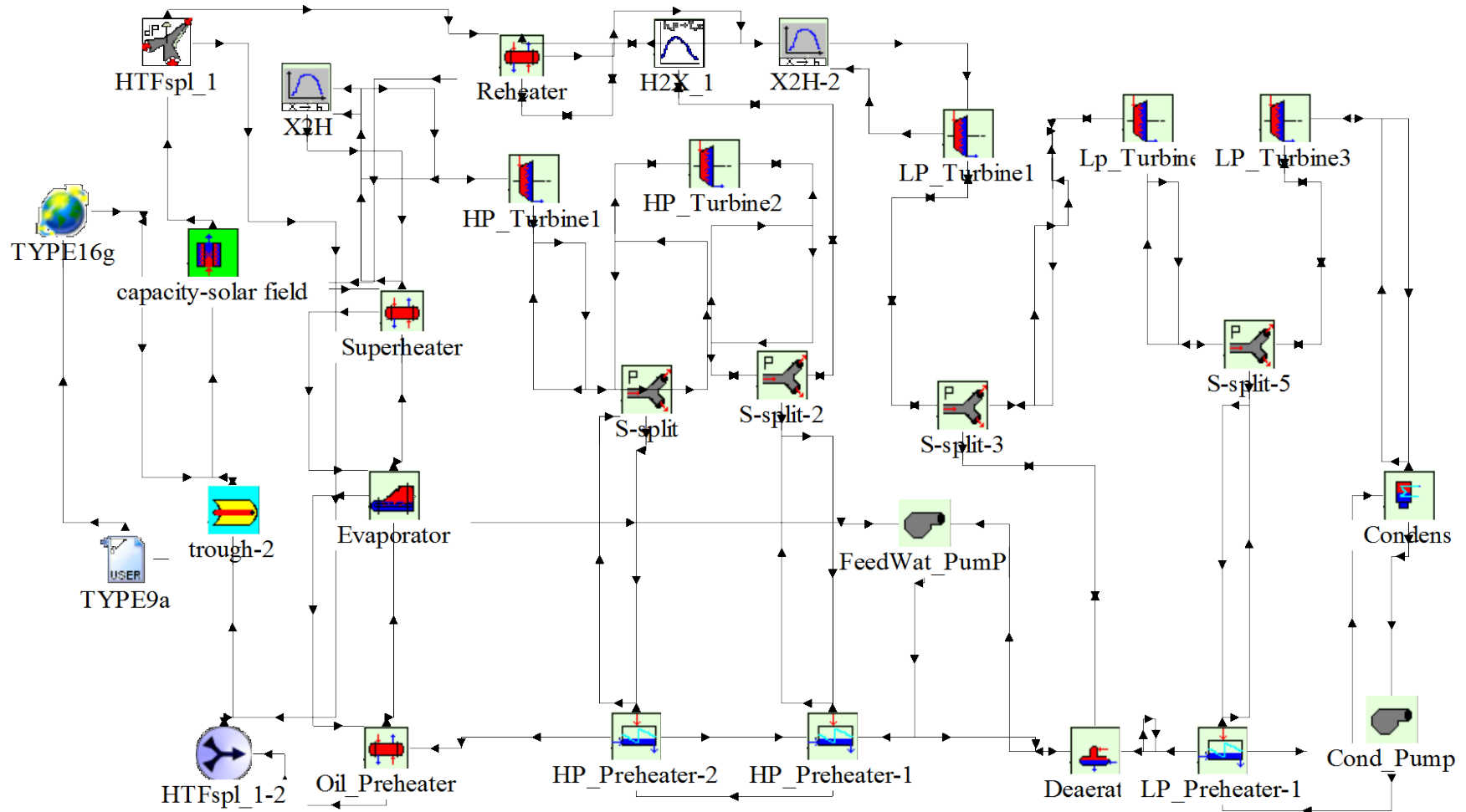

Figure 5 TRNSYS representation the power plant model

SIMULATION RESULTS

On a clear day such as March 16, 2001, the capacity of the power plant is achieved for a period of about 9 hours (9:00 – 17:00 hours), Fig. 7. The distribution of the direct normal insolation (DNI), the mass flow rate of the solar field HTF, the solar field inlet and outlet temperatures and the steam mass flow rate through the Rankine cycle are shown in Fig. 6 and Fig. 8-11, respectively.

Similar results are shown for a cloudy day (May 15, 2001) in Fig. 12–17. The distribution of the direct normal insolation (DNI) for May 15, 2001 is uneven, Fig. 12, so is the net power output, Fig. 13. Accordingly, conventional backup system should be available to attain the required power (10 MWe) delivery.

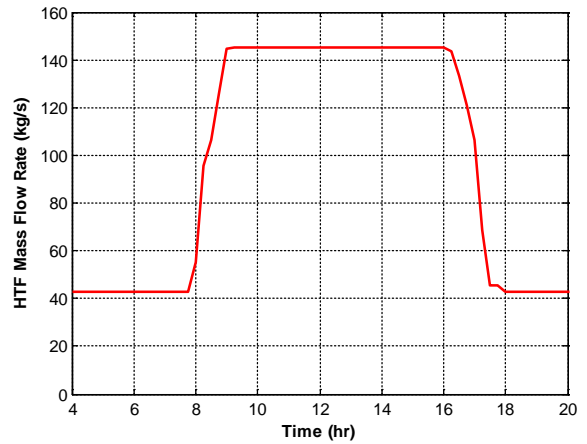

Figure 8 Solar-field HTF mass flow rate for clear day

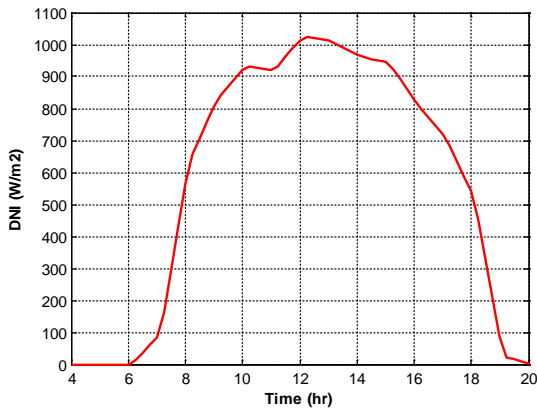

Figure 6 Direct Normal Insolation (DNI) for clear day

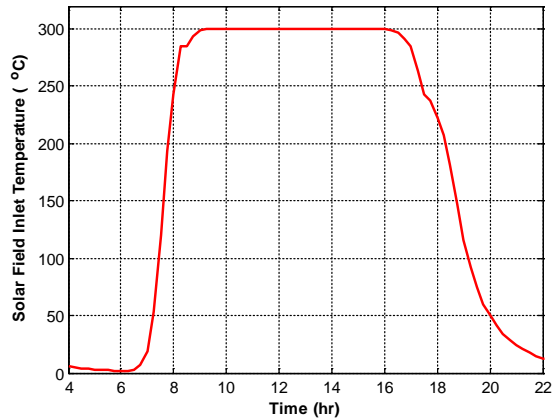

Figure 9 Solar-field inlet temperature for clear day

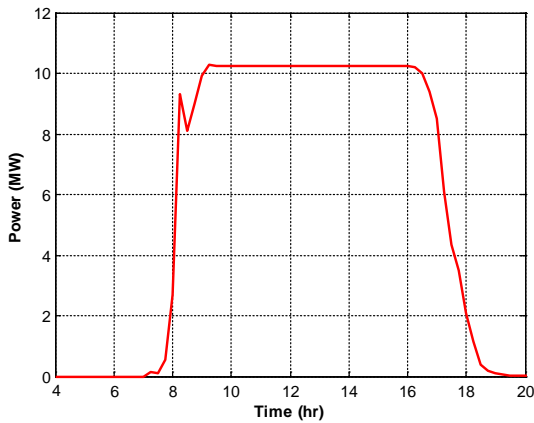

Figure 7 Net power for clear day

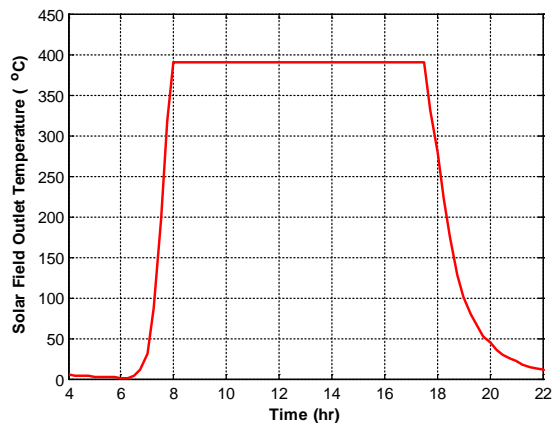

Figure 10 Solar-field outlet temperature for clear day

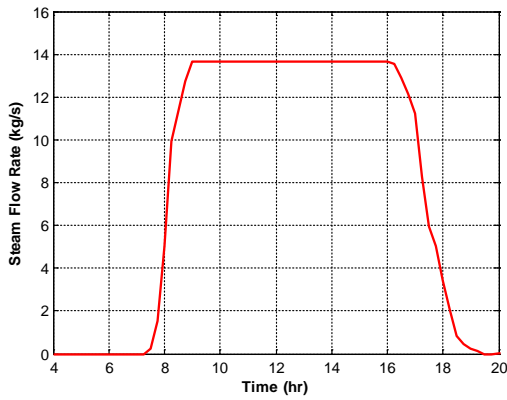

Figure 11 Mass flow rate of steam for clear day

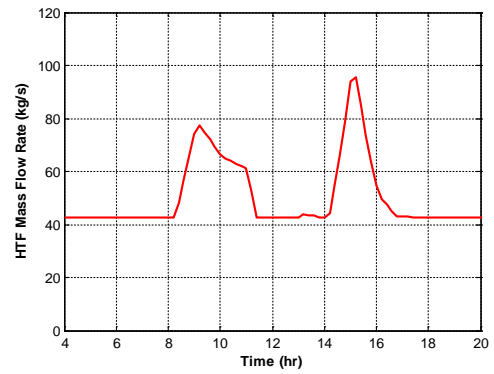

Figure 14 Solar-field HTF mass flow for cloudy day

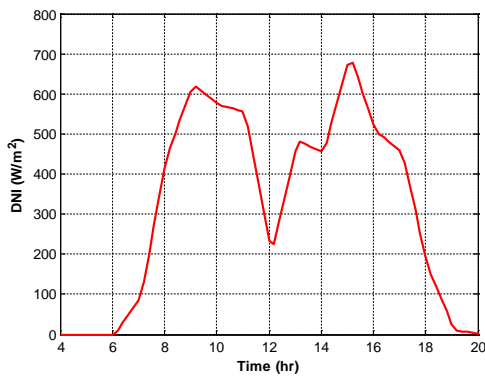

Figure 112 Direct Normal Insolation (DNI) for cloudy day

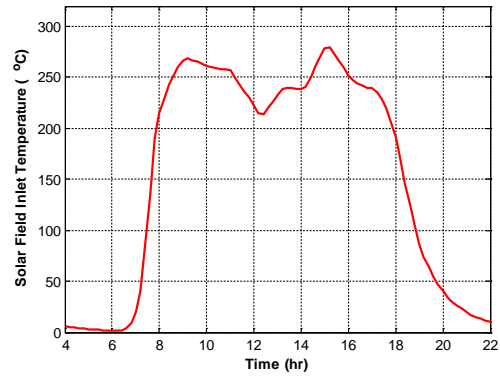

Figure 15 Solar-field inlet temperature for cloudy day

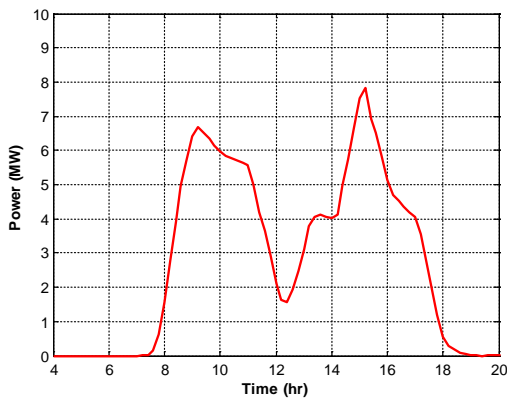

Figure 13 Net power for cloudy day

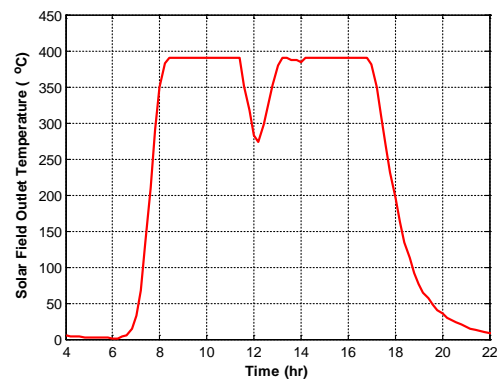

Figure 16 Solar-field outlet temperature for cloudy day

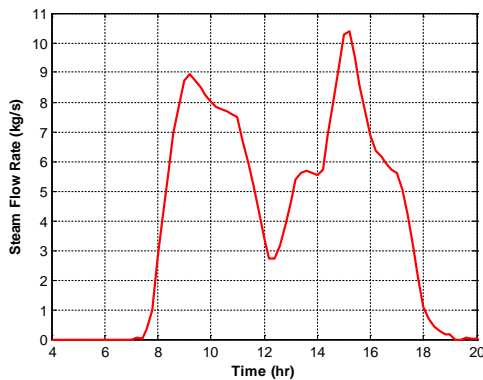

Figure 17 Mass flow rate of steam for cloudy day

CONCLUSION

In this paper a power plant is designed using appropriate considerations and assumptions. The designed power plant is modeled in two simulation programs, MATLAB and TRNSYS. MATLAB software is used to only to model the power plant at full load operation and reference weather conditions. The outputs of the code are used as reference values in TRNSYS modeling and simulation of the plant at off optimum design weather conditions. The TRNSYS model of the power plant is used to model both the solar field and the power field. This model is developed by using component from STEC library, the TRNSYS built in library and a developed component, Type 850. The main purpose of the model developed by the TRNSYS is to investigate the part load operation of the power plant.

The performance of the model developed in the TRNSYS is evaluated by considering available data for the year 2001 EC. Two days have been selected for the simulation, one for solar clear day and the other for cloudy day. The results of the simulation have shown that the mass flow rate of the HTF from the solar field and gross power produced are heavily dependent on DNI.

REFERENCES

- [1] Lippke, Frank. *Simulation of the Part Load Behavior of a 30MWe SEGS Plant*. Prepared for Sandia National Laboratories, Albuquerque, NM, SAND95-1293, June 1995.
- [2] Schwarzbözl, Peter and Zentrum, Deutsches. *A TRNSYS Model Library for Solar Thermal Electric Components (STEC)*. A Reference Manual, Release 3.0, 2006.
- [3] *Sam User Guide*, SAM Software, <https://www.nrel.gov/analysis/sam>.
- [4] *TRNSYS - A Transient System Simulation Program*. Madison, WI: University of Wisconsin-Madison Solar Energy Laboratory, <http://sel.me.wisc.edu/trnsys/>
- [5] *Weather Data*, <http://swera.unep.net>, Last Accessed: November 15, 2008.